

**D** Montageanleitung

**GB** Mounting instructions

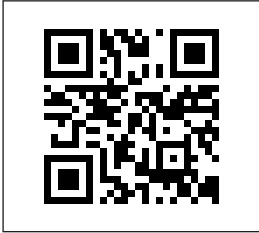

Videoanleitung | Video tutorial  
[www.hewi.com/bohrlehre](http://www.hewi.com/bohrlehre)

- D** HEWI Support 0049 5691 82-300 (D),  
00 800 4394 4394 (A, CH Freecall Festnetz)
- GB** HEWI support 0044 1634 258200 (UK),  
0049 5691 82-0 (International)
- F** Support HEWI 0033 472 83 09 09 (F),  
00 800 4394 4394 (BE, LU, CH appel gratuit, poste fixe)
- NL** HEWI support 00 800 4394 4394 (BE, LU, NL gratis, vaste lijn)
- I** HEWI supportotel 0049 5691 82 0
- E** HEWI soporte 0049 5691 82 0
- PL** HEWI wsparcie 0048 022 330 0052

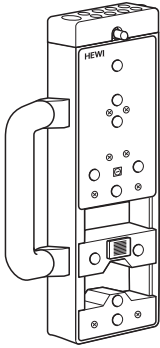

Bohrlehre  
Installation jig

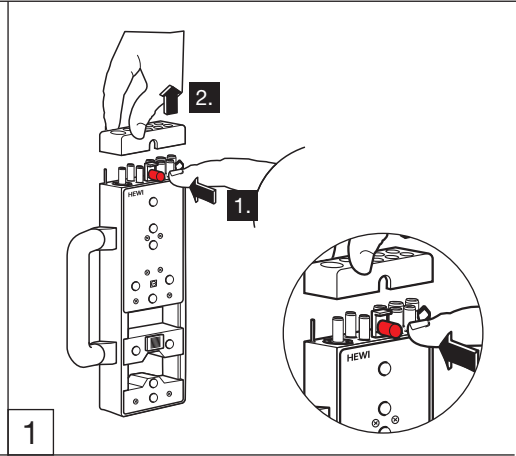

1

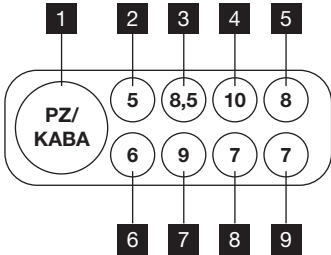
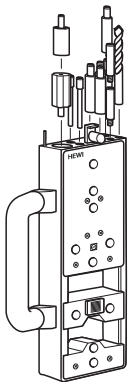

**1** ø 22 mm KABA (Schweiz | Switzerland)

**1** ø 17 mm Profizylinder (PZ) |  
Euro cylinder

**2** ø 5 mm Zentrierdorn | Centering pin

**3** ø 8,5 mm Zentrierdorn | Centering pin  
(Österreich | Austria)

**4** ø 10 mm Zentrierdorn | Centering pin

**5** ø 8 mm Zentrierdorn | Centering pin

**5** ø 8 mm Zentrierdorn | Centering pin

**6** ø 6 mm Zentrierdorn | Centering pin





**7** ø 9 mm Zentrierdorn | Centering pin

**8** ø 7 mm geteilter Zentrierdorn, auch als  
Verlängerung nutzbar |  
Split centering pin, also usable  
as extension

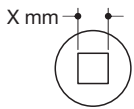
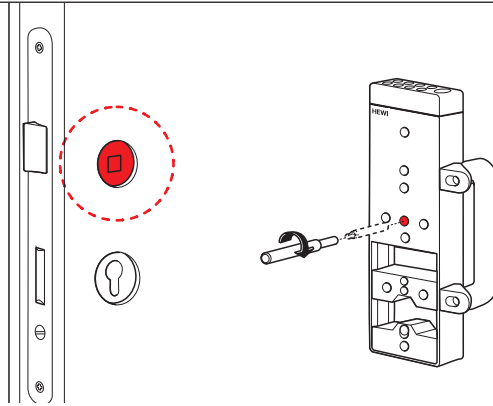
**9** ø 7 mm Bohrer | Drill bit

2



-  ø 10 mm
-  ø 9 mm
-  ø 8,5 mm
-  ø 8 mm
-  ø 7 mm

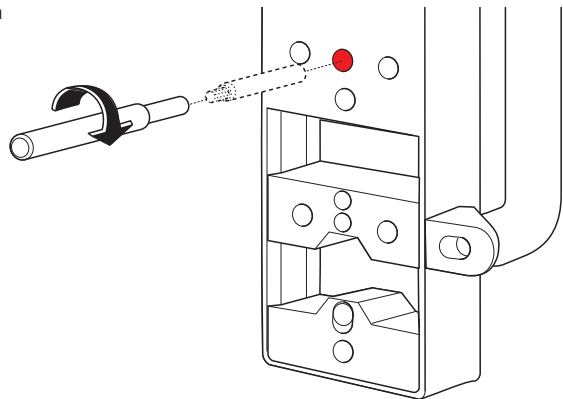

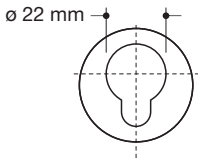
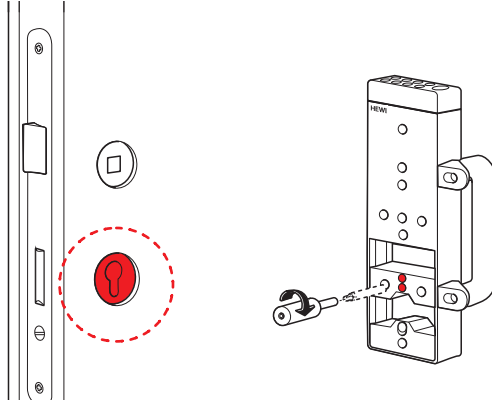

KABA  
ø 22 mm

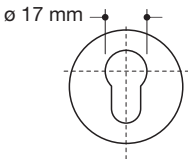

Profilzylinder (PZ)  
Euro cylinder  
ø 17 mm

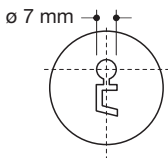

Buntbart (BB)  
Lever key  
ø 7 mm

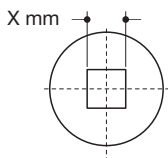
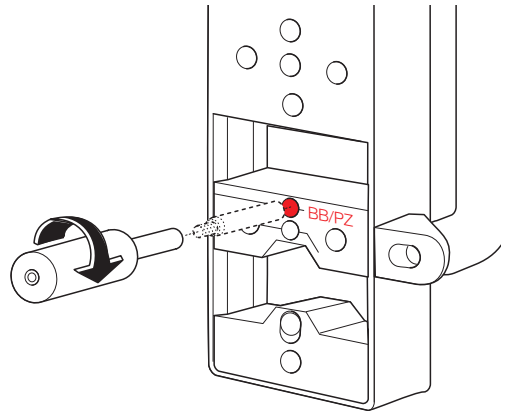

WC (NR/FB)  
vacant/engaged  
ø 8 mm  
ø 7 mm  
ø 6 mm  
ø 5 mm

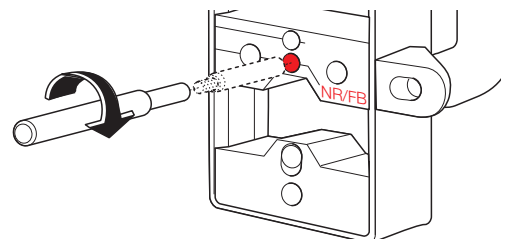

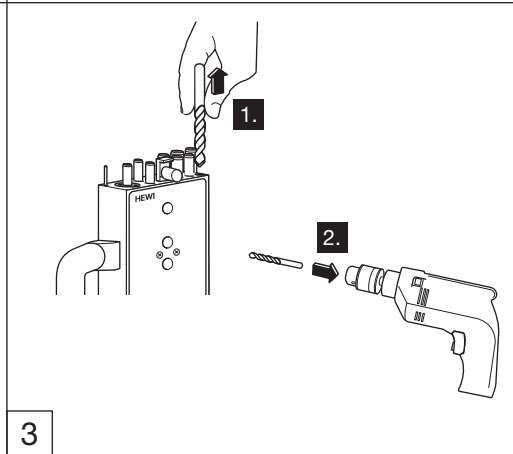
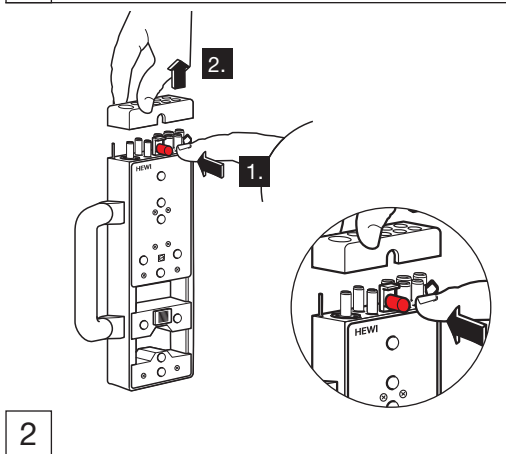
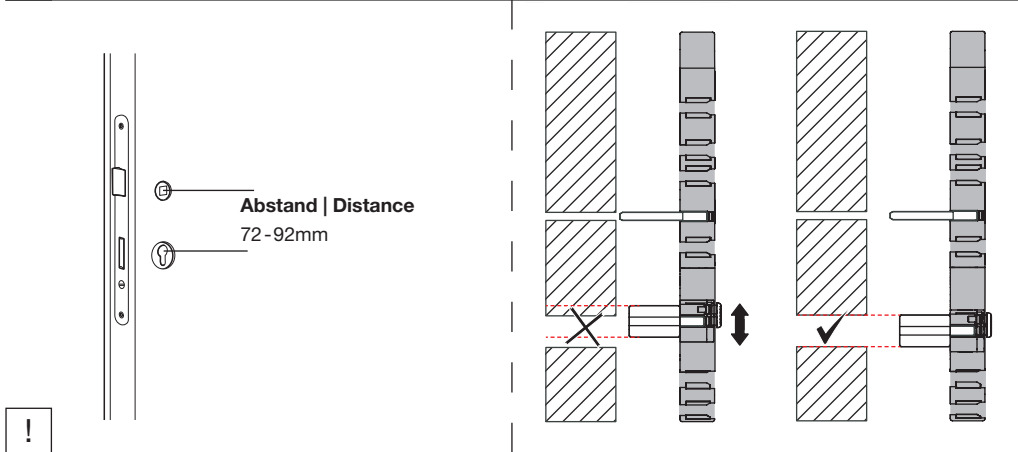
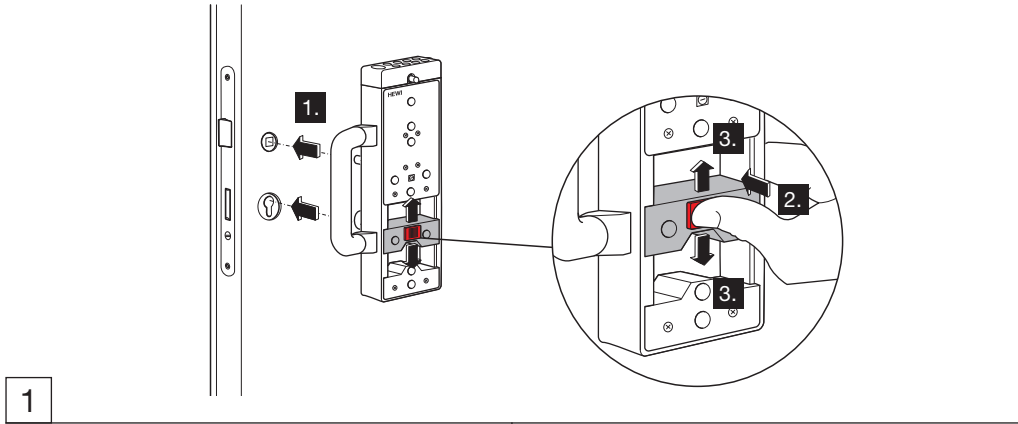



Achtung!

Nicht in oder durch den Schlosskasten bohren!

**Auswahl Bohrbilder für Schilder und Rosetten siehe Seiten 8-9.**

Very important to note!

Do not drill into or through the lockcase!

**Drill pattern for backplate and roses see pages 8-9.**

!

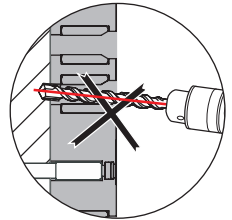
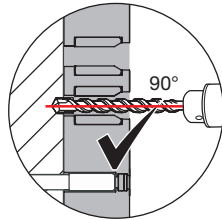
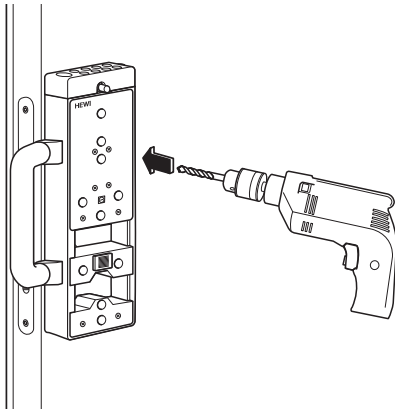

4

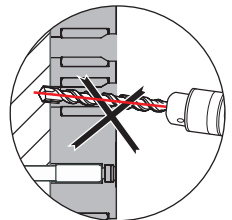
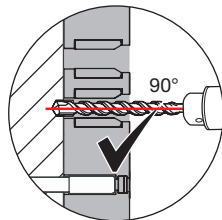
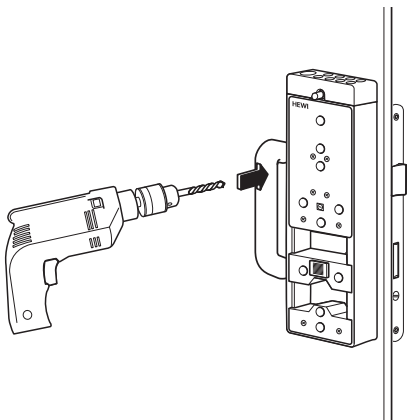

5

**Rosette | Roses**

305...  
306...  
307...  
308...

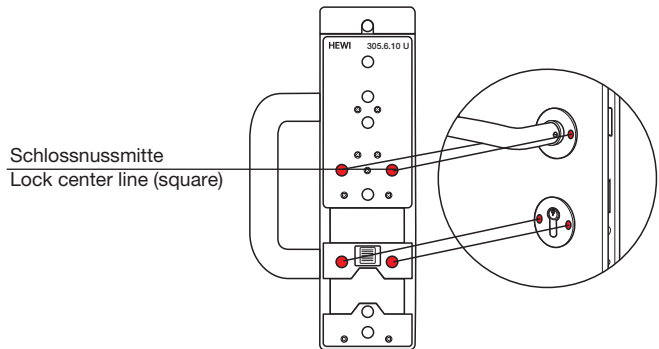

**Schild | Backplate**

217...R  
230...R 230...H  
285...R

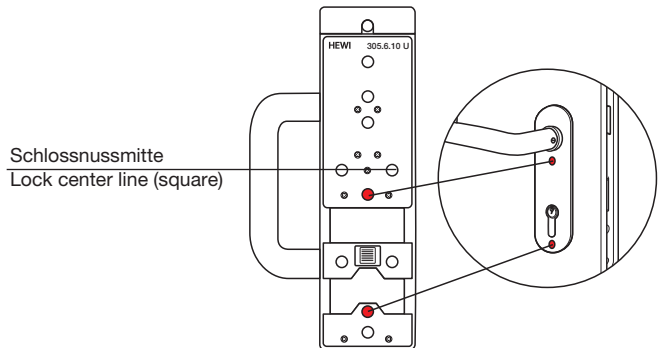

**Schutzbeschlag (Kurzschild) | Security backplate (short)**

...ES1

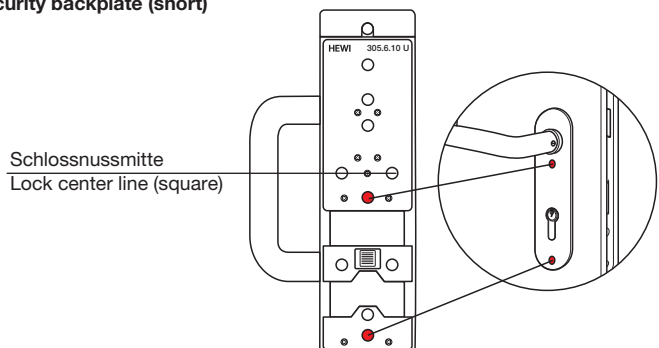



**Schild | Backplate**  
230...E

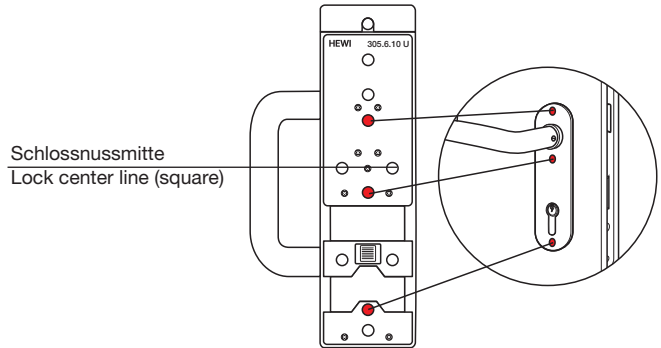

**Schild | Backplate**  
235...R 219...H  
220...H  
235...H  
236...H

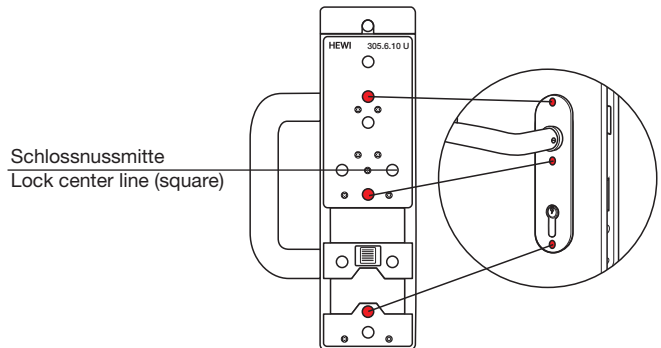

**Schutzbeschlag (Langschild) | Security backplate (long)**  
...ES3

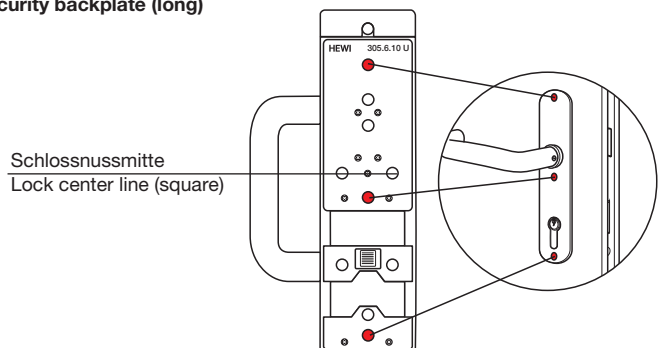





# HEWI

[www.hewi.com](http://www.hewi.com)

## **Deutschland**

HEWI Heinrich Wilke GmbH

Postfach 1260

D-34442 Bad Arolsen

Telefon: +49 5691 82-0

Telefax: +49 5691 82-319

[info@hewi.de](mailto:info@hewi.de)